



The spray system produces clear and transparent ice cubes and the patented **Bright Cube** shape grants a longer lasting cube for you to enjoy your cold drinks

Self contained ice maker.

Up to 22kg production per 24/hr of medium ice cube.
7kg storage bin.

Complete with legs, water & drain hoses + 1 ice scoop.
10 AMP power supply.

215 mm drain height including legs to finished floor.



ICE PRODUCTION

Air Cooled Unit

Air Temp.		Water Temperature			
		32°	21°	15°	10°
°C		32°	21°	15°	10°
°F		90°	70°	60°	50°
10°		17	21	22	24
50°		37	46	49	53
21°		16	20	21	23
70°		35	44	46	51
32°		14	18	19	21
90°		31	40	42	46
38°		12	15	16	17
100°		26	33	35	37

Water Cooled Unit

Air Temp.		Water Temperature			
		32°	21°	15°	10°
°C		32°	21°	15°	10°
°F		90°	70°	60°	50°
10°		20	20.5	21.5	22.5
50°		44	45	47	50
21°		19.5	20	21	22
70°		43	44	46	49
32°		16.5	17.5	18.5	19.5
90°		36	39	41	43
38°		15	16	17	18
100°		33	35	37	40

CUBE TYPE

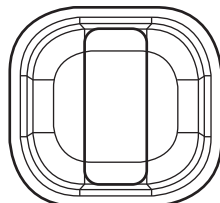
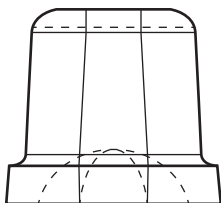

20g weight
BRIGHT CUBE
32mm x 35mm x 37mm

The Bright Ice Cube, appreciated for its versatility, is perfect for use in ice buckets, whiskey on the rocks, cocktails and appetisers. The crystal clear appearance of the Bright Cube makes it essential when a high quality is required.

CONTROL PANEL



Switch On/Off

Ice size regulation screw

BIN CAPACITY

7 Kg - 15.4 lbs | 350 pcs

DIMENSIONS

W x D x H (mm)

400 x 480 x 600/720

460 x 540 x 760

OPERATING REQUIREMENTS

Rejected Heat 1056 W

Air Volume 185 m³/h















220-240/50/1



R134a GWP = 1430

MIN		MAX	
10°C (50°F)		40°C (104°F)	
5°C (41°F)		35°C (95°F)	
- 10 %		+ 10 %	
1 Bar (14 psi)		5 Bar (70 psi)	

SPECIFICATIONS

	 cond	 comp. W	 ABS. W	 Fuse	 kWh/100kg	 L / hr	 kg	 lbs	 kg	 lbs	 Ton CO2 equiv.
CS25 A		667	460	10	42.7	2.08	34	75	42	93	0.329
CS25 W		667	410	10	37.5	32.3	34	75	42	93	0.286

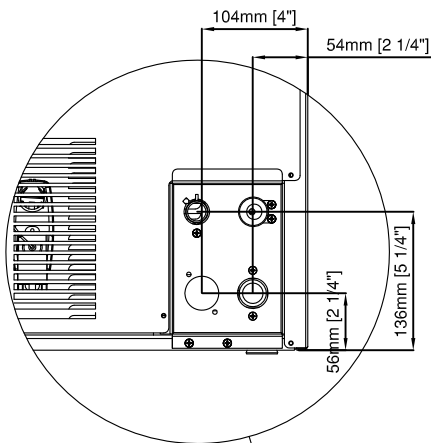

Back View
Vista Posteriore

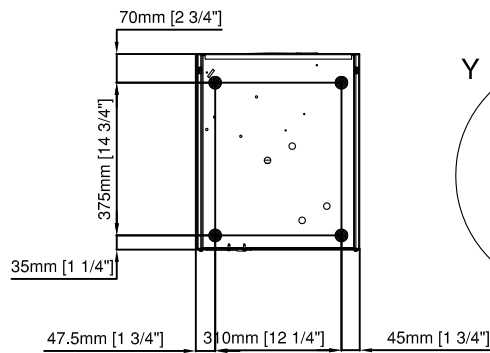
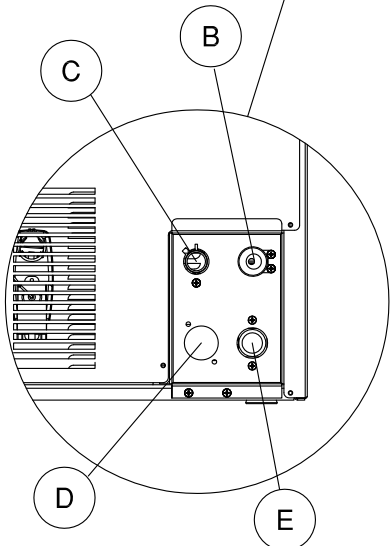
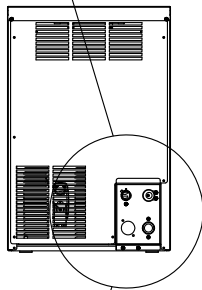

Front View
Vista Frontale

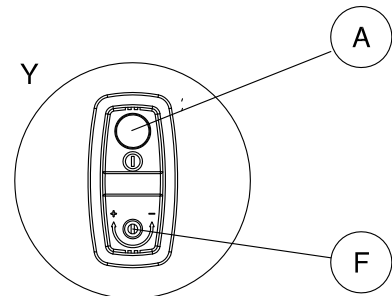
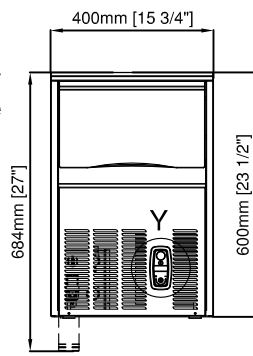

Top View
Vista Superiore

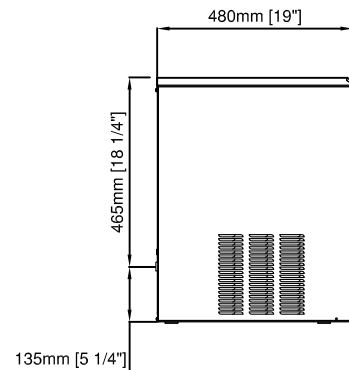
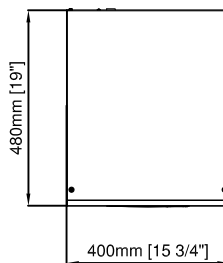

Lateral View
Vista Laterale

- A** Switch On/Off
- B** Electrical cable supply
- C** Water outlet connection 20mm diam.
- D** Water outlet connection water condensation 20mm diam.
- E** Water inlet connection 3/4" gas
- F** Ice size regulation screw